

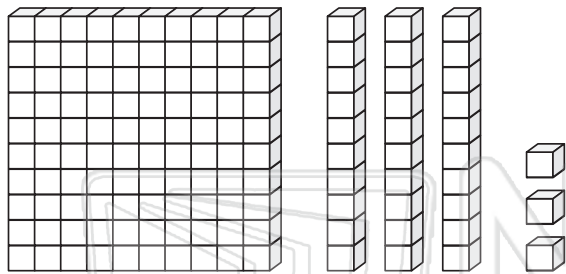

Name _____ Class _____ Date _____

Write each number in standard form.



a. _____

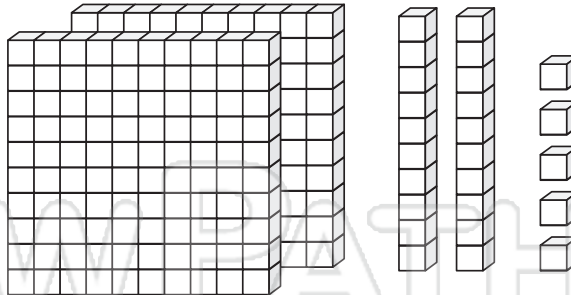

e. _____



b. _____



PREVIEW

Please [Sign In](#) or [Sign Up](#) to download the printable version of this worksheet

c. _____

g. _____

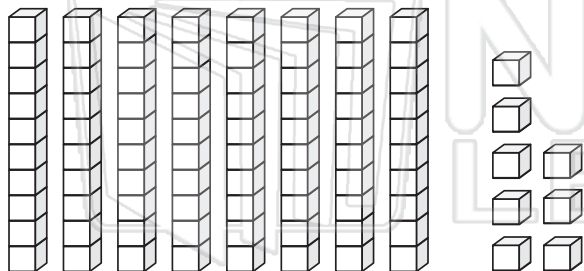

d. _____

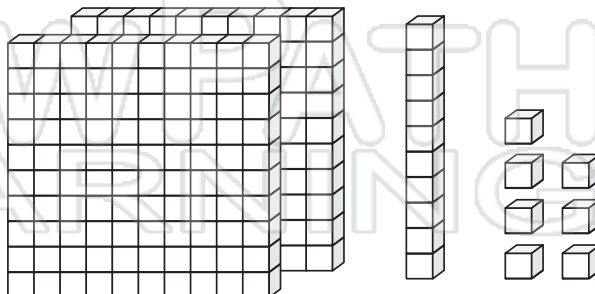

h. _____



Name _____ Class _____ Date _____

Write each number in standard form.

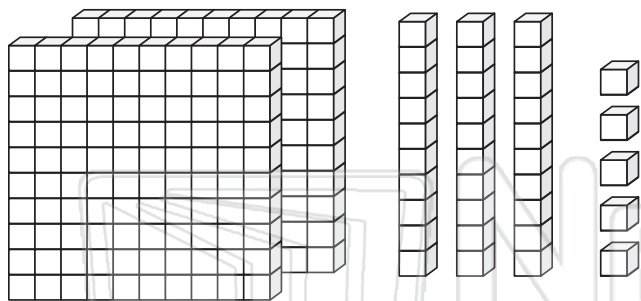

a. _____

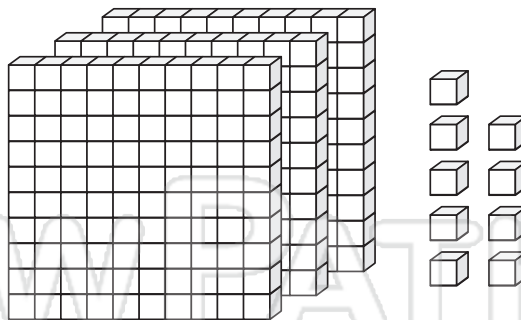

e. _____

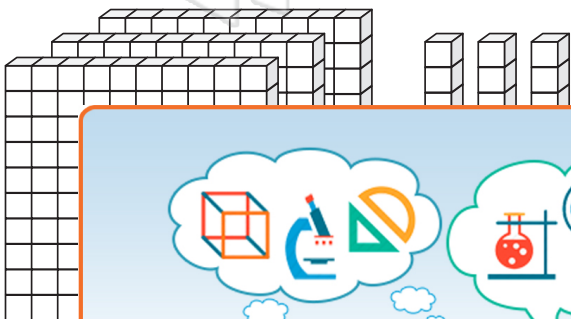

b. _____



PREVIEW

Please [Sign In](#) or [Sign Up](#) to download the printable version of this worksheet

c. _____

g. _____

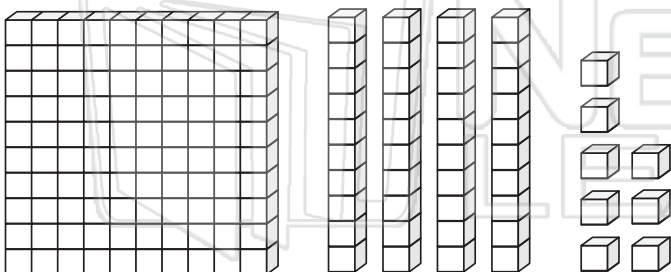

d. _____

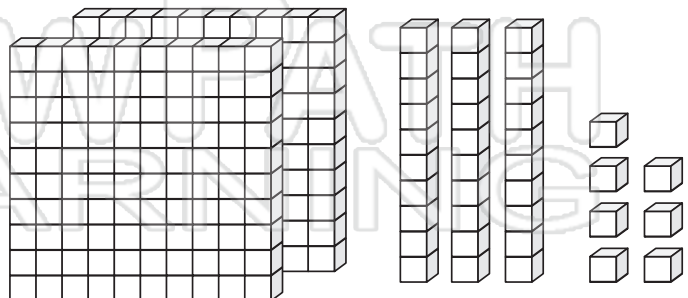

h. _____



Name _____ Class _____ Date _____

Write each number in standard form.

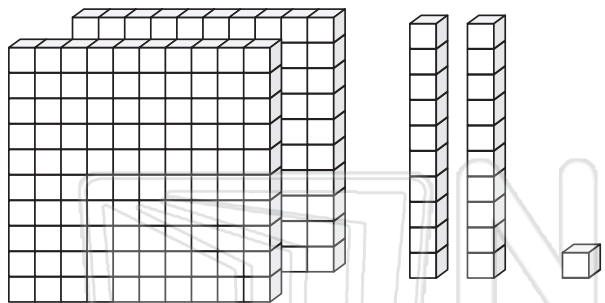

a. _____

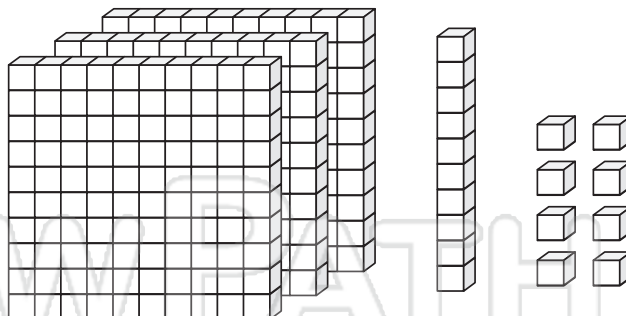

e. _____

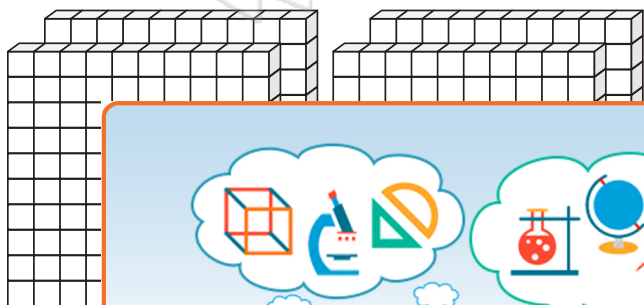

b. _____



PREVIEW

Please [Sign In](#) or [Sign Up](#) to download the printable version of this worksheet

c. _____

g. _____

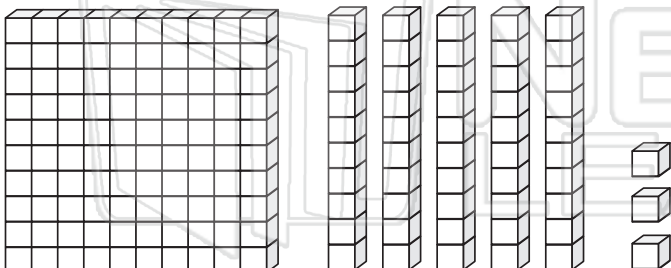

d. _____

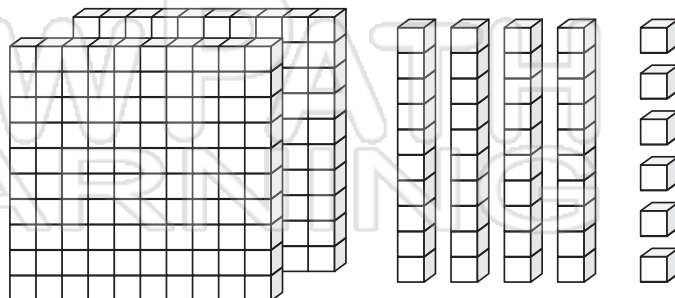

h. _____



Name _____ Class _____ Date _____

Write each number in standard form.

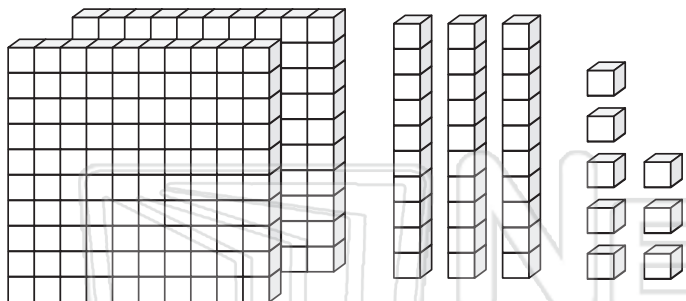

a. _____

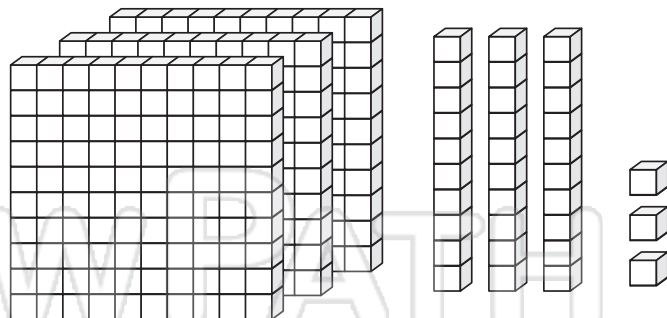

e. _____

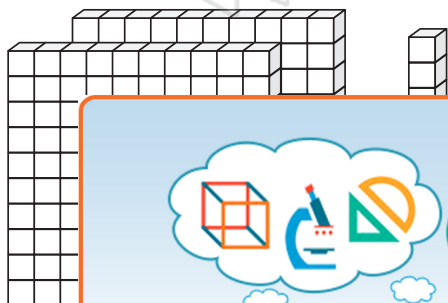

b. _____

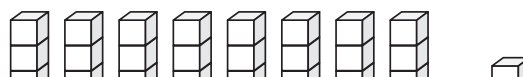

PREVIEW

Please [Sign In](#) or [Sign Up](#) to download the printable version of this worksheet

c. _____

g. _____

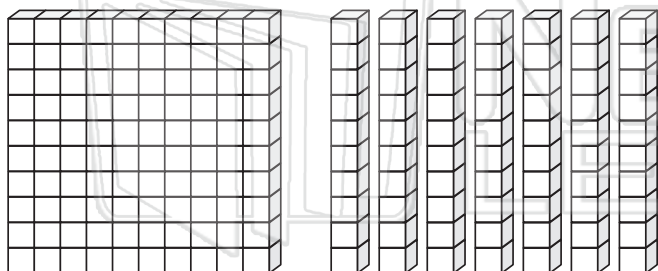

d. _____

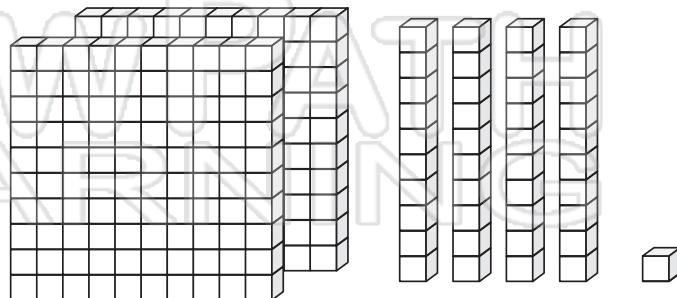

h. _____



Name _____ Class _____ Date _____

Write each number in standard form.

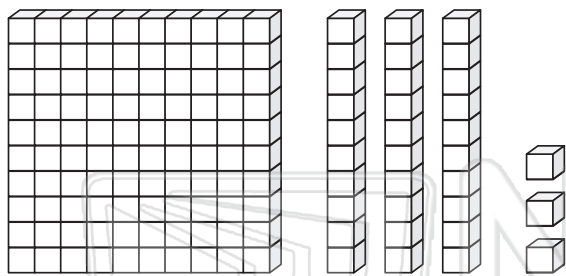

a. 133

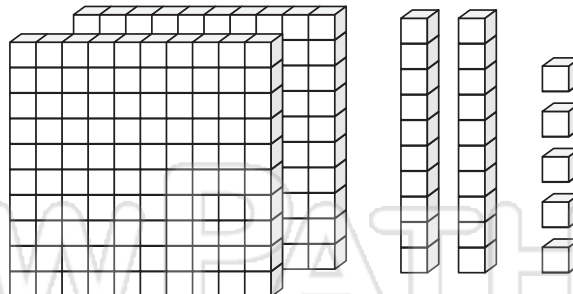

e. 225



b. _____

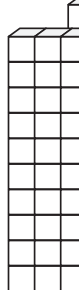

c. 219

PREVIEW

Please [Sign In](#) or [Sign Up](#) to download the printable version of this worksheet

g. 174

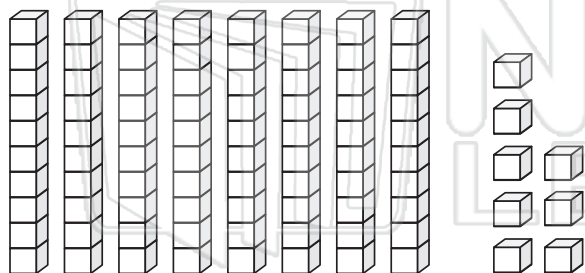

d. 88

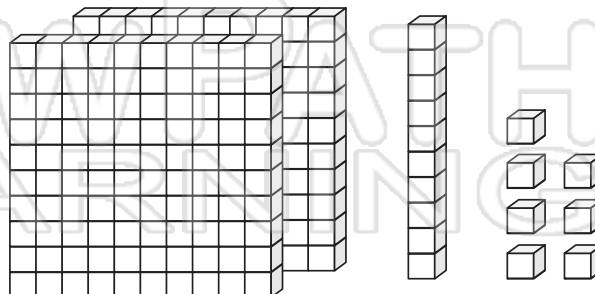

h. 217



Name _____ Class _____ Date _____

Write each number in standard form.

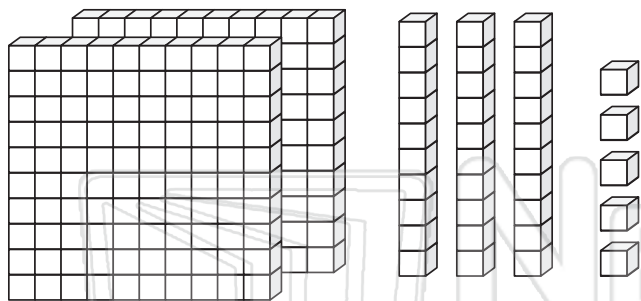

a. 235

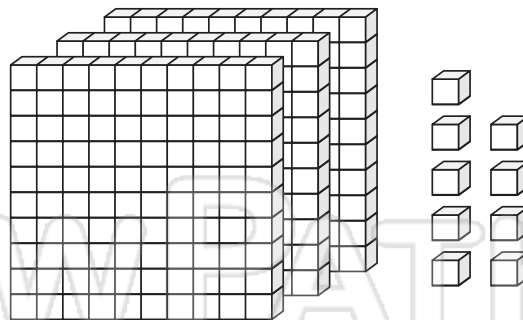

e. 309

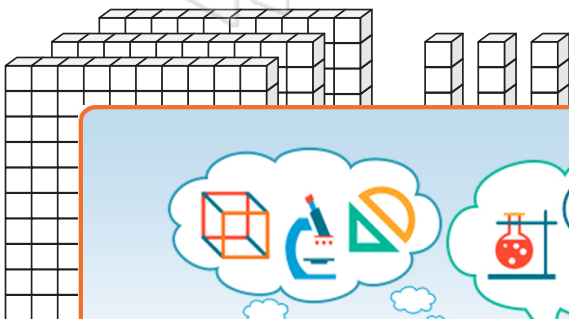

b. _____

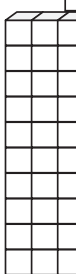

c. 260

PREVIEW

Please [Sign In](#) or [Sign Up](#) to download the printable version of this worksheet

g. 182

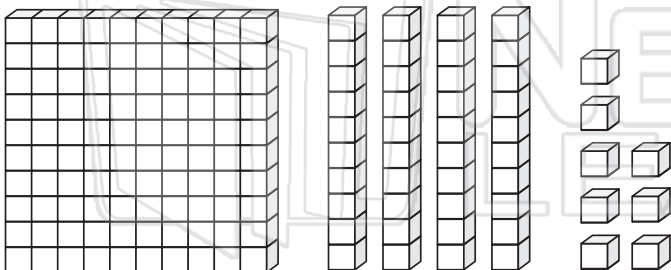

d. 148

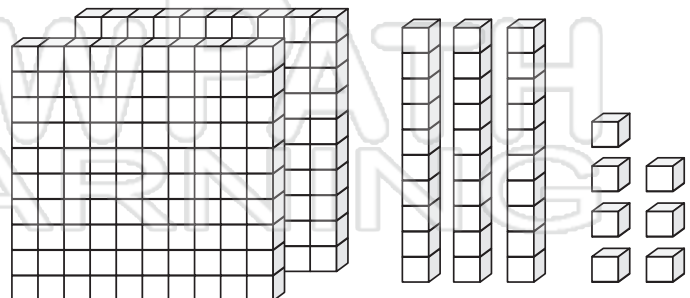

h. 237



Name _____ Class _____ Date _____

Write each number in standard form.

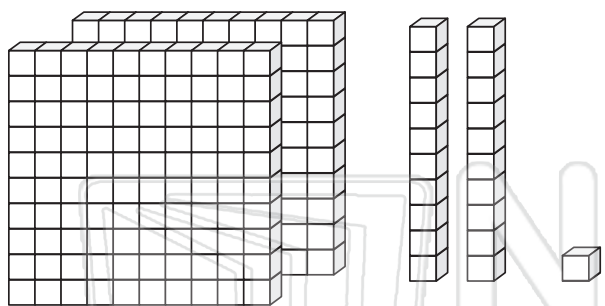

a. 221

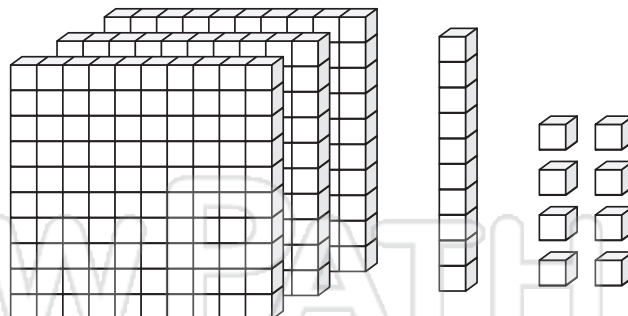

e. 318

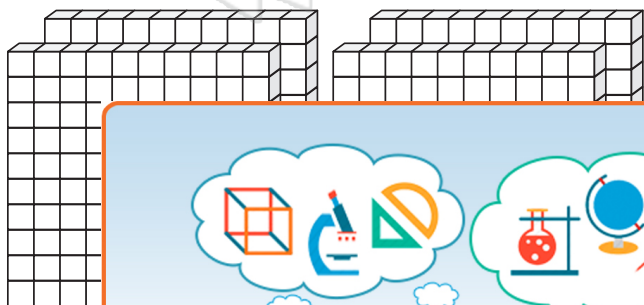

b. _____



g. 167

PREVIEW

Please Sign In or Sign Up to download the printable version of this worksheet



c. 252

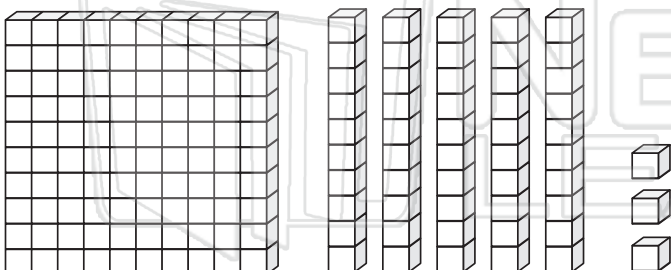

d. 153

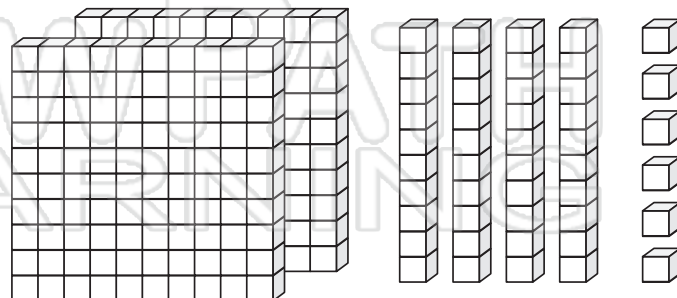

h. 246



Name _____ Class _____ Date _____

Write each number in standard form.

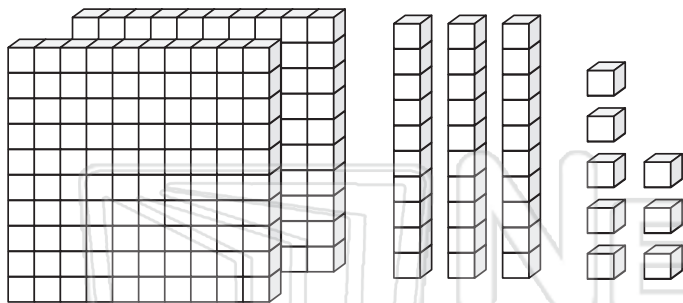

a. 238

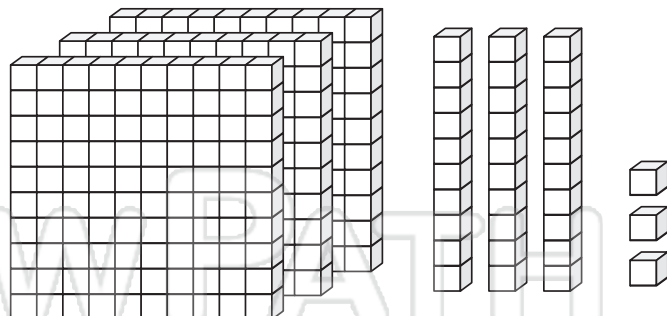

e. 333

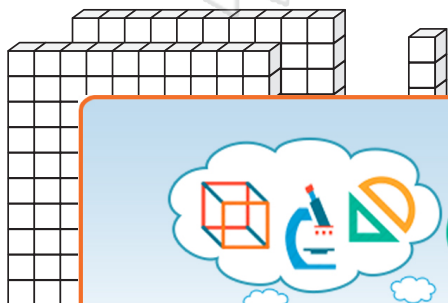

b.



PREVIEW

Please [Sign In](#) or [Sign Up](#) to download the printable version of this worksheet

c. 308

g. 136

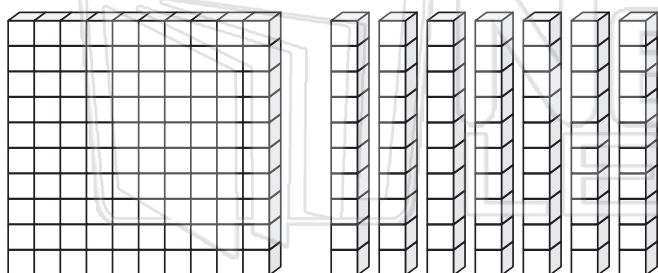

d. 170

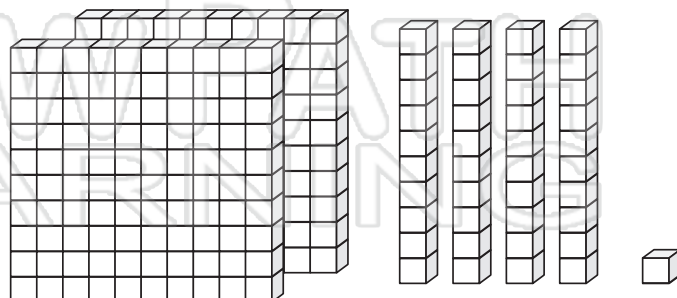

h. 241